

AAZLED200/ASY

Aztec Asymmetric Floodlight 200W



Features

High performance die-cast aluminium LED floodlight suitable for industrial applications

High output, high efficiency asymmetric lens technology for anti-light pollution

Pre-installed breathable gland prevents internal moisture accumulation

Bracket design allows installation without removing mounting bracket

High efficiency up to 143 Lm/W

Pre-wired with 1.5 metre of rubber insulated cable for ease of installation

Non-dimmable

General Information

Lamp Type	LED
Colour / Finish	Black
IP Rating	IP66
IK Rating	IK08
Class Protection	1
Internal / External	External
Surface / Recessed / Suspended	Surface
Lifetime (Hrs)	L80 B10 54,000h
Warranty (Years)	5
CE Mark	Yes
Width (mm)	300 mm
Height (mm)	398 mm
Depth (mm)	70 mm

Technical Information

Wattage	200W
Lumens Delivered	28250lm
Lm/W	141lm/W
Beam Angle	60/120
CRI	70
CCT	5000K
Input	220/240V
Hertz	50/60Hz
Operating Temp	-30°C to 50°C
SDCM	5

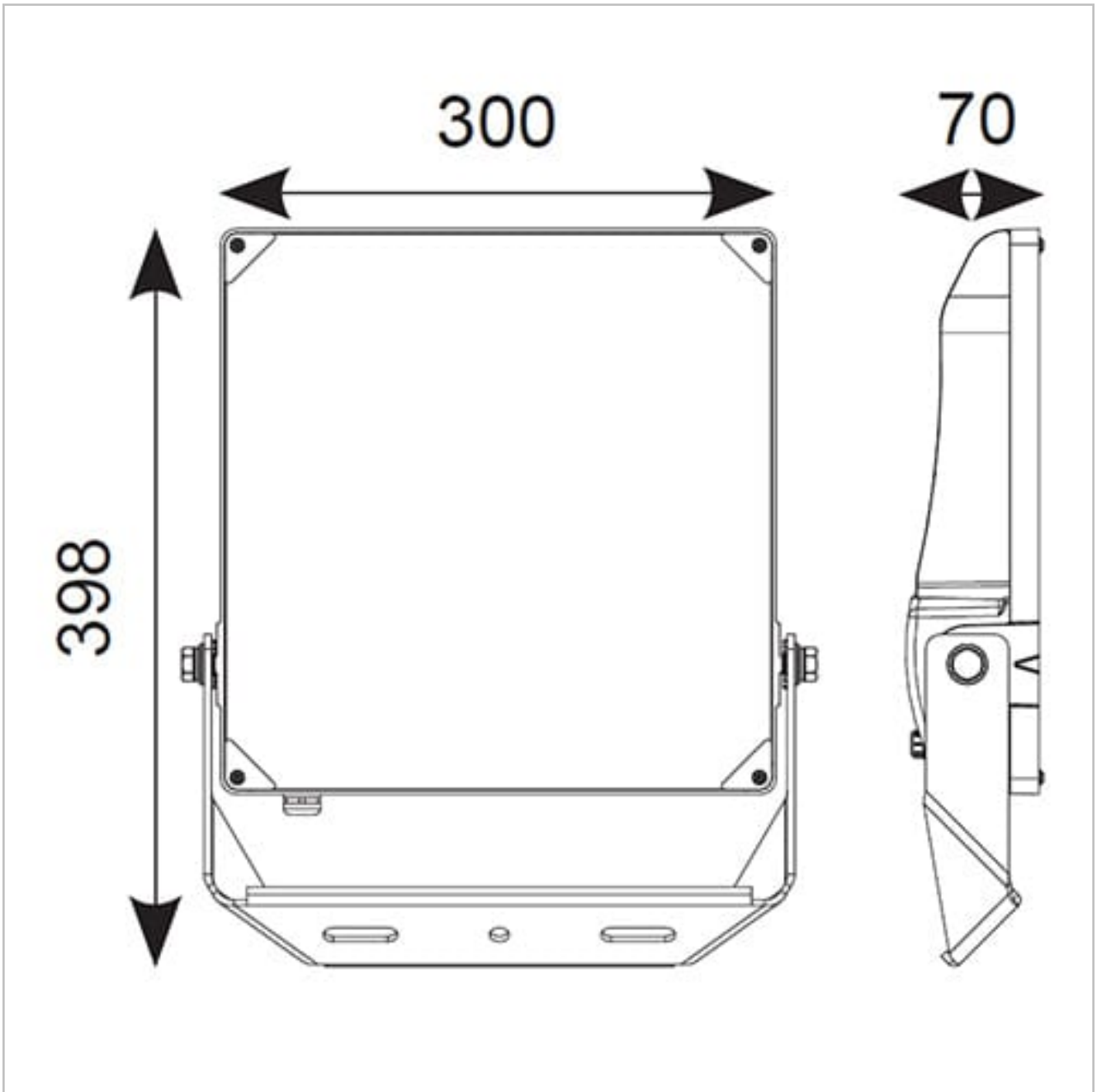

Datasheet generated from <https://onetimepim.com> last updated Thursday, October 6, 2022 8:27:10 AM