



Technical Data

Round Pin And Export Socket Outlets

Brief product description:

The subtle design will blend with any décor - suitable for domestic or commercial installations.

Universal socket will accept BS, USA & CEE plugs.

Features:

- Stylish modern profile
- Covers to conceal fixing screws
- Colour coded terminals for easy installation
- Colour coded terminals with backed out captive screws for easy installation

Product Images

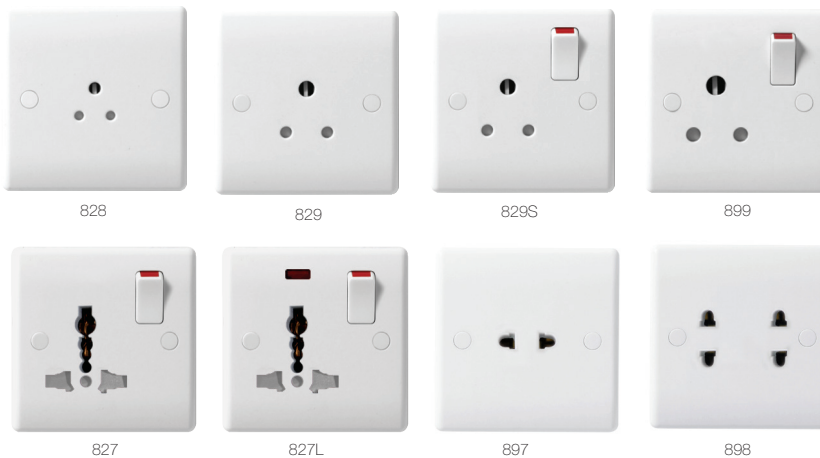

Technical Specifications

Standard(s)	BS 546 (828, 829, 829s, 899 products) BS 5733 (897, 898 products)
Rating	2 Amp 250V~ (828 products) 5 Amp 250V~ (829, 829S products) 13 Amp 250V~ (827, 827L products) 15 Amp 250V~ (829 products) 16 Amp 250V~ (897, 898 products)
Contact Gap	3.0mm minimum (827, 827L, 829S, 899 products)
Switch type	Single pole (827, 827L, 829S, 897, 898, 899 products)
Terminal Capacity - L & N	4 x 1.0mm ² 3 x 1.5mm ² 1 x 2.5mm ² 1 x 4.0mm ² (828, 829, 829S products) 3 x 2.5mm ² 3 x 4mm ² 2 x 6.0mm ² (827, 827L, 899 products)
RoHS Directive	No
WEEE Directive	No
Mounting Box Depth(Min)	25mm (828, 829, 829S, 898 products) 35mm (827, 827L, 899 products)
Fixing Centres	60.3mm
Size	86mm x 86mm x 24mm (828 product) 86mm x 86mm x 23.6mm (829, 829S products) 86mm x 86mm x 31mm (899 product) 86mm x 86mm x 32mm (827, 827L products) 86mm x 86mm x 32.4mm (897 product) 86mm x 86mm x 25.2mm (898 product)

Round Pin And Export Socket Outlets

Line Diagrams

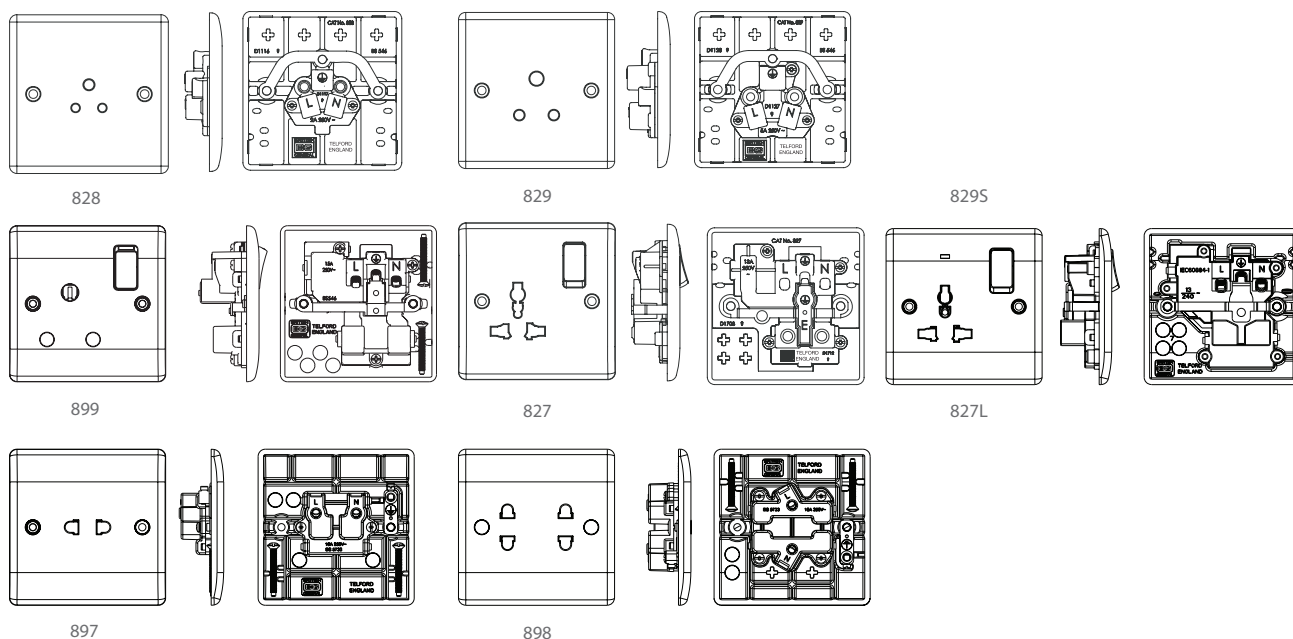

Packaging Information

Cat No.	Description	Packaging Type			Pack Quantity			Barcode		
		Product	Inner Box	Outer Box	Each	Inner Box	Outer Box	Individual	Inner Box	Outer Box
828	2A 1G, USW SKT	Nexus PolyBag	Nexus Inner	Nexus Outer	1	10	100	5050765000716	5050765000802	5050765000819
829	5A 1G, USW SKT	Nexus PolyBag	Nexus Inner	Nexus Outer	1	10	100	5050765000826	5050765000833	5050765000840
829S	5A 1G, SW SKT	Nexus PolyBag	Nexus Inner	Nexus Outer	1	10	100	5050765018050	5050765000833	5050765000840
899	15A 1G, SW SKT	Nexus PolyBag	Nexus Inner	Nexus Outer	1	10	100	5050765000888	5050765000895	5050765000901
827	1G Uni-SW SKT	Nexus PolyBag	Nexus Inner	Nexus Outer	1	10	100	5050765002868	5050765002875	5050765002882
827L	1G Uni-SW SKT+Neon	Nexus PolyBag	Nexus Inner	Nexus Outer	1	10	100	5050765004411	5050766004428	5050766004435
897	16A 1G Euro SKT	Nexus PolyBag	Nexus Inner	Nexus Outer	1	10	100	5050765002806	5050765002752	5050765002769
898	16A 2G Euro SKT	Nexus PolyBag	Nexus Inner	Nexus Outer	1	10	100	5050765002837	5050765002783	5050765002790

Weights & Dimensions

Cat No.	Description	Dimension (W x L x H) cm			Weight (g)			CBM (m ³)
		Product	Inner Box	Outer Box	Each	Inner Box	Outer Box	Outer Box
828	2A 1G, USW SKT	8.6 x 8.6 x 2.4	12.7 x 18.2 x 9.5	26.5 x 50.5 x 20.5	69	791	8250	0.02
829	5A 1G, USW SKT	8.6 x 8.6 x 2.4	12.7 x 18.2 x 9.5	26.5 x 50.5 x 20.5	83	930	9550	0.02
829S	5A 1G, SW SKT	8.6 x 8.6 x 2.4	12.7 x 18.2 x 9.5	26.5 x 50.5 x 20.5	83	930	9550	0.02
899	15A 1G, SW SKT	8.6 x 8.6 x 2.4	12.7 x 18.2 x 9.5	26.5 x 50.5 x 20.5	96	1110	11630	0.02
827	1G Uni-SW SKT	8.6 x 8.6 x 2.4	12.7 x 18.2 x 9.5	26.5 x 50.5 x 20.5	105	1210	12020	0.02
827L	1G Uni-SW SKT+Neon	8.6 x 8.6 x 2.4	12.7 x 18.2 x 9.5	26.5 x 50.5 x 20.5	110	1240	12600	0.02
897	16A 1G Euro SKT	8.6 x 8.6 x 2.4	12.7 x 18.2 x 9.5	26.5 x 50.5 x 20.5	71	810	8700	0.02
898	16A 2G Euro SKT	8.6 x 8.6 x 2.4	12.7 x 18.2 x 9.5	26.5 x 50.5 x 20.5	79	890	9800	0.02

Round Pin And Export Socket Outlets

Installation Information

Safety Warning

Before use please read carefully and use in accordance with these safety wiring instructions.

Before commencing any electrical work ensure the supply **is switched off at the mains**. Either by switching off the consumer unit or by removing the appropriate fuse.

Wiring should be in accordance with the latest edition of the IEE regulations (BS 7671).

Wire Identification – Twin & Earth Cable

EARTH = Green/Yellow Slewing

NEUTRAL = Black (pre Apr 04) / Blue (after Apr 04)

LIVE = Red (pre Apr 04) / Brown (after Apr 04)



Technical Helpline: 03300 249 279

If in doubt consult a competent electrician.

The ends of the individual conductors should have the insulation removed by approx. 12mm. Any bare earth conductors should be sleeved to within 12mm of the ends. (These details are for general information only and conductor lengths may need to be trimmed in certain installations).

General Installation Instructions

- 1) If using the new product to replace an old one, note the cable connections and wire up new product in the same way as the old one, with Earthing as stated in these instructions.
- 2) Ensure the mounting box (metal or patress) for either flush or surface mounting is the appropriate size for the product.
- 3) Route the cable through the most suitable entry point of the mounting box. If a metal box is used, a protective cable grommet should be used.
- 4) Cables should be prepared so a sufficient conductor length reaches the terminals. Strip the ends of the individual conductors so that an adequate length enters the terminals.
- 5) Carefully arrange the wiring to lie along the edges of the product or box, keeping the central area clear.
- 6) To assist with the correct installation please consult the appropriate wiring diagram on this leaflet.
- 7) When connecting the new accessory ensure that only the bare end of the wire enters the terminal, and no bare wires are visible.

Always tighten the terminal screws securely, but do not overtighten.

An earth connection should always be made between the mounting box earth terminal, and the accessory earth terminal, where fitted. If this earth wire is bare, it is essential that it is sheathed with a length of green/yellow sleeving.

8) Carefully position the accessory into the wall box, ensuring that no wires are trapped between the plate and the wall. Do not overtighten the screws. (Fit screw covers + clip-on)

9) Once work has been completed correctly, replace the fuse for the circuit, switch the power back on, and test.

The product is now ready for use.

* Note - If your installation uses a four lug metal mounting box, remove the top and bottom lugs or bend fully back.

2 Amp Unswitched Socket

Connect the cables as shown in the diagram.

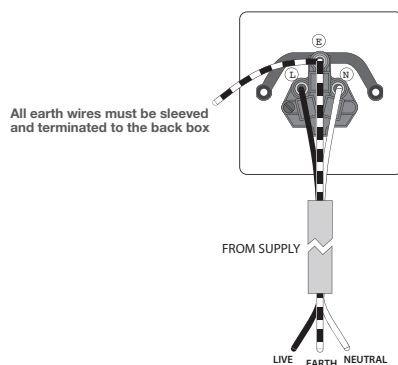

5 Amp Unswitched Socket

Connect the cables as shown in the diagram.

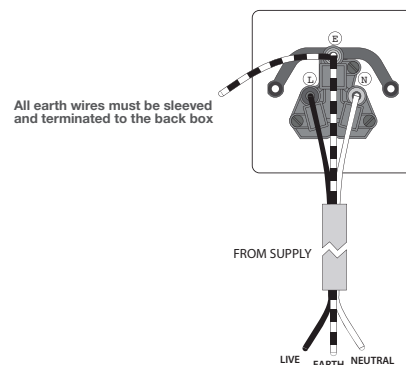

5 Amp Switched Socket

Connect the cables as shown in the diagram.

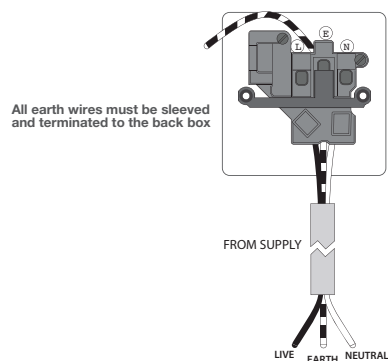

15 Amp Switched Socket

Connect the cables as shown in the diagram.

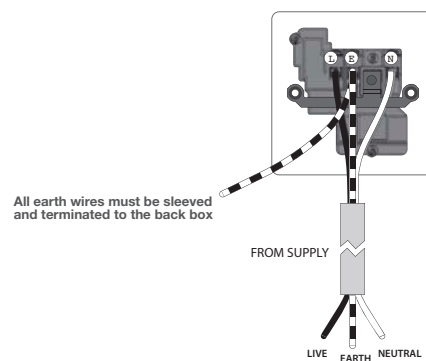



Technical Data

Round Pin And Export Socket Outlets

Brief product description:

A standard range of white moulded wall accessories offering superb quality and exceptional value.
 Universal socket will accept BS, USA & CEE plugs.

Features:

- A standard design - suitable for domestic or commercial installations.
- Colour coded terminals with backed out captive screws for easy installation

Product Images

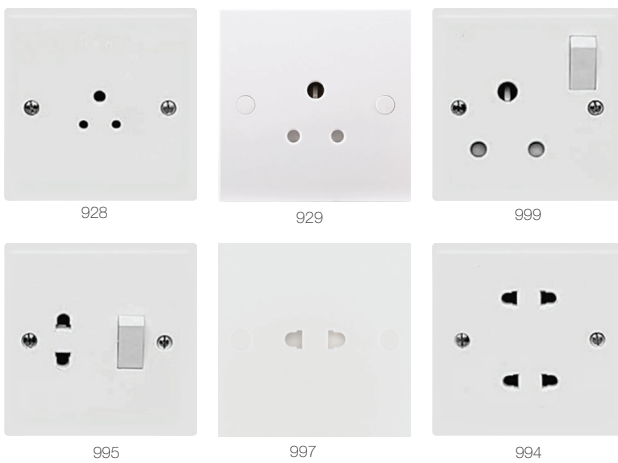

Technical Specifications

Standard(s)	BS 546 (928, 929, 999 products) BS 5733 (997 products)
Rating	2 Amp 250V~ (928 products) 5 Amp 250V~ (929 products) 15 Amp 250V~ (999 products) 16 Amp 125/250V~ (997 products)
Contact Gap	3.0mm minimum (999 products)
Switch type	Single pole (999 products)
Terminal Capacity - L & N	4 x 1.0mm ² 3 x 1.5mm ² 1 x 2.5mm ² 1 x 4.0mm ² (928, 929 products) 3 x 2.5mm ² 3 x 4mm ² 2 x 6.0mm ² (999 products) 2 x 1.5mm ² 1 x 2.5mm ² 1 x 4.0mm ² (997 products)
RoHS Directive	No
WEEE Directive	No
Mounting Box Depth(Min)	25mm (928, 929 products) 35mm (999 products)
Fixing Centres	60.3mm
Size	86mm x 86mm x 24mm (928 product) 86mm x 86mm x 23.6mm (929 products) 86mm x 86mm x 32mm (999 products) 86mm x 86mm x 32.4mm (997 product)

Round Pin And Export Socket Outlets

Line Diagrams

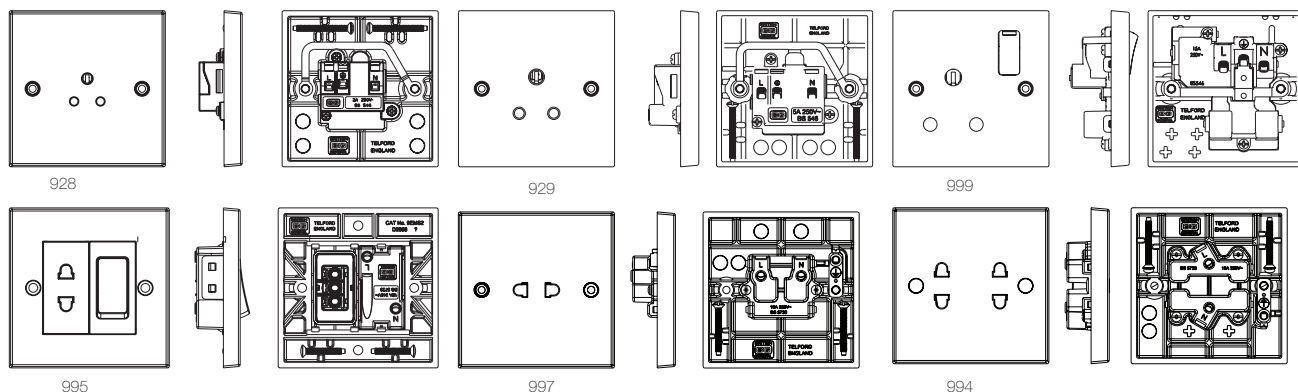

Packaging Information

Cat No.	Description	Packaging Type			Pack Quantity			Barcode		
		Product	Inner Box	Outer Box	Each	Inner Box	Outer Box	Individual	Inner Box	Outer Box
928	2A 1G, USW SKT	Plain Bag	Plain Inner	Plain Outer	1	10	100	5021166928002	5021166928095	5021166928088
929	5A 1G, USW SKT	Plain Bag	Plain Inner	Plain Outer	1	10	100	5021166929009	5021166929092	5021166929085
999	15A 1G, SW SKT	Plain Bag	Plain Inner	Plain Outer	1	10	100	5021166999002	5021166999095	5021166999088
995	1G Uni-SW SKT	Plain Bag	Plain Inner	Plain Outer	1	10	100	5021166995004	5021166995097	5021166995080
997	1G Shutter Euro SKT	Plain Bag	Plain Inner	Plain Outer	1	10	100	5021166997008	5021166997091	5021166997084
994	16A 2G Euro SKT	Plain Bag	Plain Inner	Plain Outer	1	10	100	5021166994007	5021166994090	5021166994083

Weights & Dimensions

Cat No.	Description	Dimension (W x L x H) cm			Weight (g)			CBM (m ³)
		Product	Inner Box	Outer Box	Each	Inner Box	Outer Box	Outer Box
928	2A 1G, USW SKT	8.6 x 8.6 x 2.4	12.7 x 18.2 x 9.5	26.5 x 50.5 x 20.5	79	890	9800	0.02
929	5A 1G, USW SKT	8.6 x 8.6 x 2.4	12.7 x 18.2 x 9.5	26.5 x 50.5 x 20.5	85	930	9550	0.02
999	15A 1G, SW SKT	8.6 x 8.6 x 2.4	12.7 x 18.2 x 9.5	26.5 x 50.5 x 20.5	105	1210	12020	0.02
995	1G Uni-SW SKT	8.6 x 8.6 x 2.4	12.7 x 18.2 x 9.5	26.5 x 50.5 x 20.5	83	930	9550	0.02
997	1G Shutter Euro SKT	8.6 x 8.6 x 2.4	12.7 x 18.2 x 9.5	26.5 x 50.5 x 20.5	71	810	8700	0.02
994	16A 2G Euro SKT	8.6 x 8.6 x 2.4	12.7 x 18.2 x 9.5	26.5 x 50.5 x 20.5	85	930	9550	0.02

Installation Information

Safety Warning

Before use please read carefully and use in accordance with these safety wiring instructions. Before commencing any electrical work ensure the supply is **switched off at the mains**. Either by switching off the consumer unit or by removing the appropriate fuse. Wiring should be in accordance with the latest edition of the IEE regulations (BS 7671).

Wire Identification – Twin & Earth Cable

EARTH = Green/Yellow Sleaving

NEUTRAL = Black (pre Apr 04) / Blue (after Apr 04)

LIVE = Red (pre Apr 04) / Brown (after Apr 04)



Technical Helpline: 03300 249 279
If in doubt consult a competent electrician.

The ends of the individual conductors should have the insulation removed by approx. 12mm. Any bare earth conductors should be sleeved to within 12mm of the ends. (These details are for general information only and conductor lengths may need to be trimmed in certain installations).

General Installation Instructions

- 1) If using the new product to replace an old one, note the cable connections and wire up new product in the same way as the old one, with Earthing as stated in these instructions.
- 2) Ensure the mounting box (metal or patress) for either flush or surface mounting is the appropriate size for the product.
- 3) Route the cable through the most suitable entry point of the mounting box. If a metal box is used, a protective cable grommet should be used.
- 4) Cables should be prepared so a sufficient conductor length reaches the terminals. Strip the ends of the individual conductors so that an adequate length enters the terminals.
- 5) Carefully arrange the wiring to lie along the edges of the product or box, keeping the central area clear.
- 6) To assist with the correct installation please consult the appropriate wiring diagram on this leaflet.
- 7) When connecting the new accessory ensure that only the bare end of the wire enters the terminal, and no bare wires are visible.

Always tighten the terminal screws securely, but do not overtighten.

An earth connection should always be made between the mounting box earth terminal, and the accessory earth terminal, where fitted. If this earth wire is bare, it is essential that it is sheathed with a length of green/yellow sleeving.

8) Carefully position the accessory into the wall box, ensuring that no wires are trapped between the plate and the wall. Do not overtighten the screws. (Fit screw covers + clip-on)

9) Once work has been completed correctly, replace the fuse for the circuit, switch the power back on, and test.

The product is now ready for use.

* Note - If your installation uses a four lug metal mounting box, remove the top and bottom lugs or bend fully back.

Round Pin And Export Socket Outlets

Installation Information

2 Amp Unswitched Socket

Connect the cables as shown in the diagram.

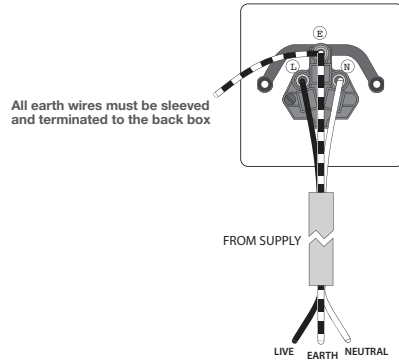

5 Amp Unswitched Socket

Connect the cables as shown in the diagram.

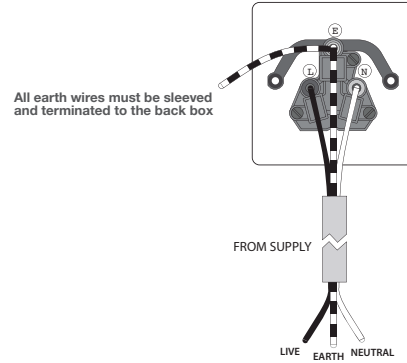

5 Amp Switched Socket

Connect the cables as shown in the diagram.

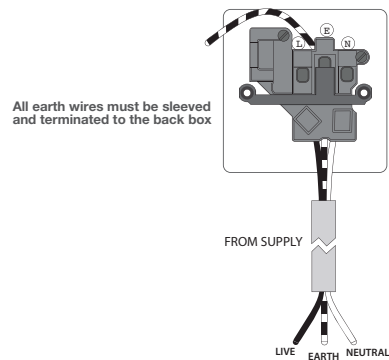

15 Amp Switched Socket

Connect the cables as shown in the diagram.

