



Technical Data

10 Amp - 10 Ax Plate Switches

Brief product description:

BG's Nexus range of plate switches have been designed to perform at 10AX inductive loads.

The subtle design will blend with any décor - suitable for domestic or commercial installations. The Fan Isolator switch has a triple pole switching design, however can be used for double pole applications if required.

Features:

- White moulded round edge, sleek and slim with softly rounded edges
- 10 Amp, 10AX inductive rated
- Easy to install, supplied with fixing screws and installation instructions
- Captive, backed out terminal screws for fast installation
- The Fan Isolator switch has a triple pole switching design, however can be used for double pole applications if required.

Product Images



811/812/813



814



815



842



843



844

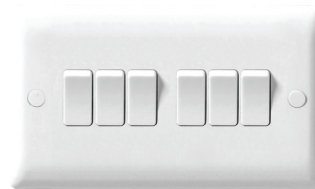

846

Technical Specifications

Standard(s)	BS EN 60669-1
ASTA Approval	Yes, License Number 1010, 815 License Number 1015
Rating	10 Amp, 250V~(10AX – no derating for inductive or fluorescent loads)
Contact Gap	3.0mm minimum
Terminal Capacity - L & N	4 x 1.0mm ² 4 x 1.5mm ² 2 x 2.5mm ² 1 x 4.0mm ²
RoHS Directive	No
WEEE Directive	No
Mounting Box Depth(Min)	16mm (811,812, 813, 814, 815, 842, 843 products) 25mm (844, 846 products)
Fixing Centres	60.3mm (811,812, 813, 814, 815, 842, 843 products) 120.6mm (844, 846 products)
Size	86mm x 86mm x 6.9mm (811,812, 813, 814, 815, 842, 843 products) 146.5mm x 86mm x 6.9mm (844, 846 products)



10 Amp - 10 Ax Plate Switches

Line Diagrams

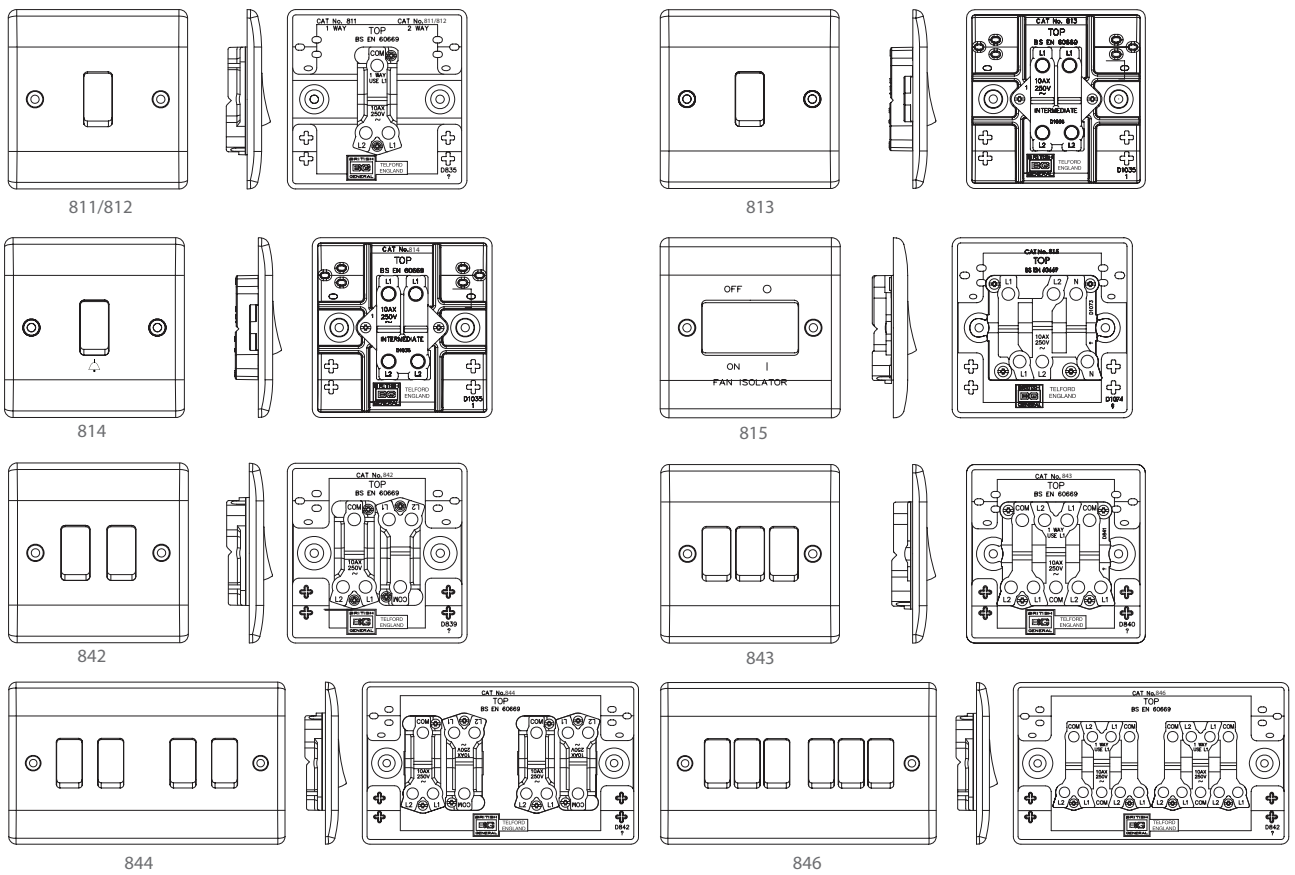

Packaging Information

Cat No.	Description	Packaging Type			Pack Quantity			Barcode		
		Product	Inner Box	Outer Box	Each	Inner Box	Outer Box	Individual	Inner Box	Outer Box
811	10AX 1G, 1W	Nexus PolyBag	Nexus Inner	Nexus Outer	1	10	100	5050765004442	5050765000321	5050765000338
812	10AX 1G, 2W	Nexus PolyBag	Nexus Inner	Nexus Outer	1	10	100	5050765004473	5050765000352	5050765000369
813	10AX Intermediate	Nexus PolyBag	Nexus Inner	Nexus Outer	1	10	100	5050765004503	5050765000383	5050765000390
814	10AX Bell Push	Nexus PolyBag	Nexus Inner	Nexus Outer	1	10	100	5050765004534	5050765000413	5050765000420
815	10AX Fan Isolator	Nexus PolyBag	Nexus Inner	Nexus Outer	1	10	100	5050765004565	5050765000444	5050765000451
842	10AX 2G, 2W	Nexus PolyBag	Nexus Inner	Nexus Outer	1	10	100	5050765004596	5050765000321	5050765000338
843	10AX 3G, 2W	Nexus PolyBag	Nexus Inner	Nexus Outer	1	10	100	5050765004626	5050765000475	5050765000482
844	10AX 4G, 2W	Nexus PolyBag	Nexus Inner	Nexus Outer	1	5	50	5050765004657	5050765000505	5050765000512
846	10AX 6G, 2W	Nexus PolyBag	Nexus Inner	Nexus Outer	1	5	50	5050765004688	5050765000536	5050765000543

Weights & Dimensions

Cat No.	Description	Dimension (W x L x H) cm			Weight (g)			CBM (m ³)	
		Product	Inner Box	Outer Box	Each	Inner Box	Outer Box	Outer Box	
811	10AX 1G, 1W	9.2 x 9.2 x 2.9	12.5 x 18 x 9.2	26 x 49.5 x 19	72	739	7850	0.0244	
812	10AX 1G, 2W	9.2 x 9.2 x 2.9	12.5 x 18 x 9.2	26 x 49.5 x 19	67	724	7700	0.0244	
813	10AX Intermediate	9.2 x 9.2 x 2.9	12.5 x 18 x 9.2	26 x 49.5 x 19	70	834	8800	0.0244	
814	10AX Bell Push	9.2 x 9.2 x 2.9	12.5 x 18 x 9.2	26 x 49.5 x 19	66	704	7500	0.0244	
815	10AX Fan Isolator	9.2 x 9.2 x 2.9	12.5 x 18 x 9.2	26 x 49.5 x 19	90	914	9600	0.0244	
842	10AX 2G, 2W	9.2 x 9.2 x 2.9	12.5 x 18 x 9.2	26 x 49.5 x 19	78	894	9400	0.0244	
843	10AX 3G, 2W	9.2 x 9.2 x 2.9	12.5 x 18 x 9.2	26 x 49.5 x 19	90	1014	10600	0.0244	
844	10AX 4G, 2W	9.2 x 9.2 x 2.9	12.5 x 15 x 9.2	26 x 49.5 x 16	141.5	804	8500	0.02	
846	10AX 6G, 2W	9.2 x 15.2 x 2.9	12.5 x 15 x 9.2	26 x 49.5 x 16	173	953	10000	0.02	

10 Amp - 10 Ax Plate Switches

Installation Information

Safety Warning

For your safety, this product must be installed in accordance with local building regulations. If in any doubt, or where required by the law, consult a competent person who is registered with an electrical self-certification scheme.

Further information is available online or from your Local Authority.

Please read carefully and use in accordance with these safety wiring instructions.

Before commencing any electrical work ensure the supply is switched off at the mains either by switching off the consumer unit or by removing the appropriate fuse. Wiring should be in accordance with the latest edition of the IET regulations (BS 7671). To prevent fire hazard always use cable of the correct rating, size and type for the application.

Any bare earth wires must be covered with appropriate green/yellow sleeving.

Warning do not exceed the load rating of this device as stated on the rear of the product.

If in doubt consult a competent electrician.

Wire Identification – Twin & Earth Cable

EARTH = Green/Yellow Sleeving

NEUTRAL = Black (pre Apr 04) / Blue (after Apr 04)

LIVE = Red (pre Apr 04) / Brown (after Apr 04)



Technical Helpline: 03300 249 279

If in doubt consult a competent electrician.

The ends of the individual conductors should have the insulation removed by approx. 12mm. Any bare earth conductors should be sleeved to within 12mm of the ends. (These details are for general information only and conductor lengths may need to be trimmed in certain installations).

General Installation Instructions

- 1) If using the new product to replace an old one, note the cable connections and wire up new product in the same way as the old one, with Earthing as stated in these instructions.
- 2) Ensure the mounting box (metal or patress) for either flush or surface mounting is the appropriate size for the product.
- 3) Route the cable through the most suitable entry point of the mounting box. If a metal box is used, a protective cable grommet should be used.
- 4) Cables should be prepared so a sufficient conductor length reaches the terminals. Strip the ends of the individual conductors so that an adequate length enters the terminals.
- 5) Carefully arrange the wiring to lie along the edges of the product or box, keeping the central area clear.
- 6) To assist with the correct installation please consult the appropriate wiring diagram on this leaflet.
- 7) When connecting the new accessory ensure that only the bare end of the wire enters the terminal, and no bare wires are visible.

Always tighten the terminal screws securely, but do not overtighten.

An earth connection should always be made between the mounting box earth terminal, and the accessory earth terminal, where fitted. If this earth wire is bare, it is essential that it is sheathed with a length of green/yellow sleeving.

8) Carefully position the accessory into the wall box, ensuring that no wires are trapped between the plate and the wall. Do not overtighten the screws. (Fit screw covers + clip-on)

9) Once work has been completed correctly, replace the fuse for the circuit, switch the power back on, and test.

The product is now ready for use.

* Note - If your installation uses a four lug metal mounting box, remove the top and bottom lugs or bend fully back.

One Way Switching

One way switching is used in installations that require just one switch to control a light (or circuit) i.e. on or off.

A two-way switch can be used for one-way connection, use COM and L1 terminals.

For multiple gang switches (2, 3, 4 & 6) repeat wiring method for each switch.

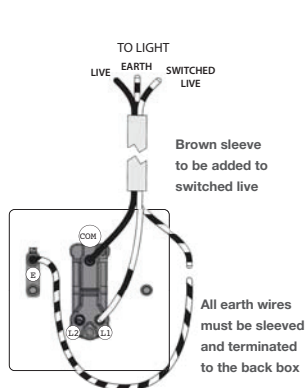

Two Way Switching

Two way switching is used where a light is controlled by two switches.

For multiple gang switches (2, 3, 4 & 6) repeat wiring method for each switch.

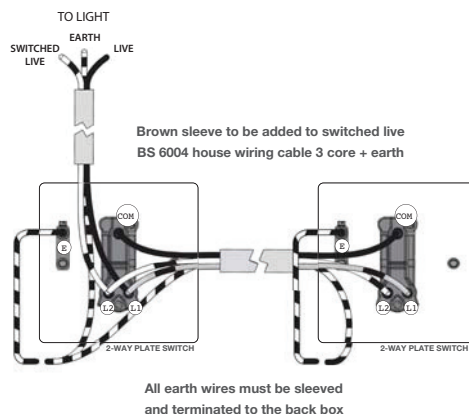

10 Amp - 10 Ax Plate Switches

Installation Information

Bell Push

The bell push is a one way switch with a retractive rocker switch. Before installing, ensure a bell unit is suitable for supply voltage.

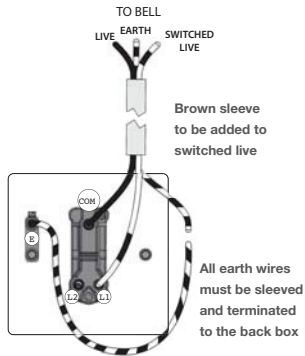

Intermediate Switching

Intermediate switching is used in installations that require three or more switches to control a light, and should be used together with two 2-way switches.

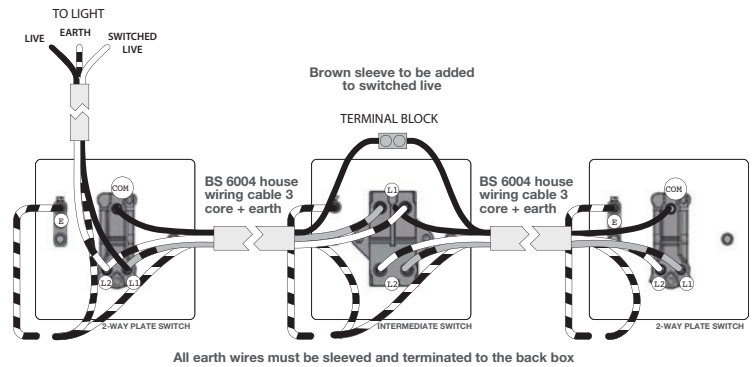

Fan Isolator - 3 Pole Switch

During repair or installation or routine maintenance the power supply to the fan unit must be disconnected. This isolating switch can be installed as shown in the diagrams to enable the remainder of the circuit to remain live.

These instructions should be read in conjunction with the instructions supplied with the fan unit and the latest IEE Wiring Regulations.

Please follow the appropriate wiring diagram below for your particular installation.

Important

The continuity of the protective conductors must be maintained. The isolator switch shall be so situated as to be inaccessible to a person using a fixed bath or shower.

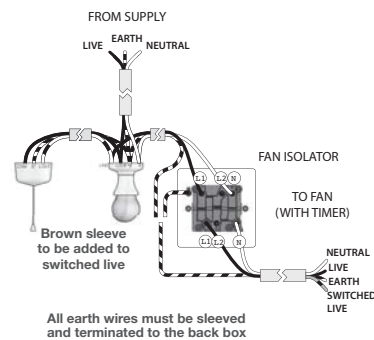
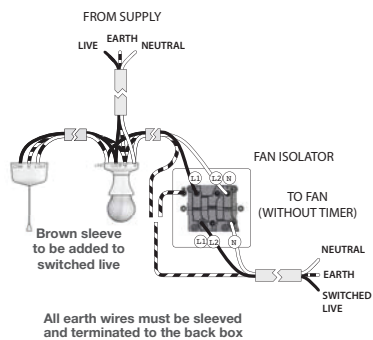
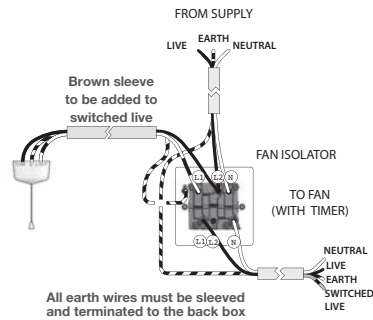
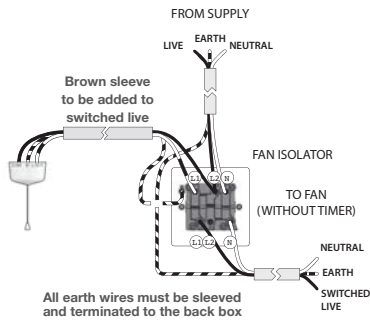



Technical Data

10 Amp - 10 AX Switches

Brief product description:

A standard range of white moulded wall accessories offering superb quality and exceptional value.

The Fan Isolator switch has a triple pole switching design, however can be used for double pole applications if required.

Features:

- White moulded square edge profile offering exceptional value
- 10 Amp, 10AX inductive rated
- Easy to install, supplied with fixing screws and installation instructions
- Captive, backed out terminal screws for fast installation
- The Fan Isolator switch has a triple pole switching design, however can be used for double pole applications if required.

Product Images



911/912/913



914



915



942



943



944



946

Technical Specifications

Standard(s)	BS EN 60669-1	 
ASTA Approval	Yes, License Number 1010, 915 License Number 1015	
Rating	10 Amp, 250V~(10AX – no derating for inductive or fluorescent loads)	
Contact Gap	3.0mm minimum	
Terminal Capacity - L & N	4 x 1.0mm ² 4 x 1.5mm ² 2 x 2.5mm ² 1 x 4.0mm ²	
RoHS Directive	No	
WEEE Directive	No	
Mounting Box Depth(Min)	16mm (911W, 912W, 913W, 914W, 915W, 942W, 943W products) 25mm (944W, 946W products)	
Fixing Centres	60.3mm (911W, 912W, 913W, 914W, 915W, 942W, 943W products) 120.6mm (944W, 946W products)	
Size	86mm x 86mm x 21.2mm (911W, 912W, 913W, 914W, 915W, 942W, 943W products) 146.5mm x 86mm x 21.2mm (944W, 946W products)	

Line Diagrams

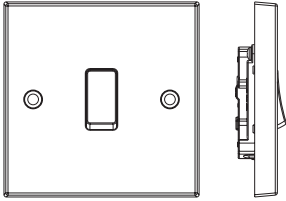

911/912

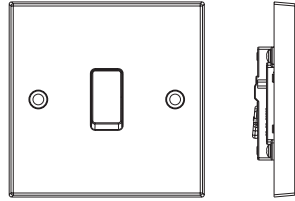
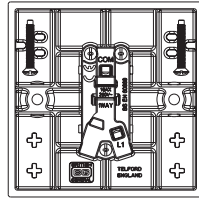

913

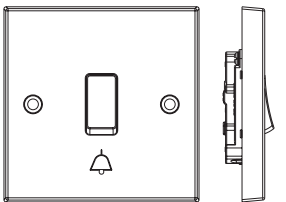
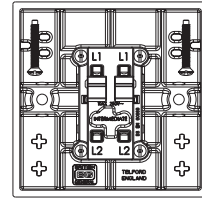

914

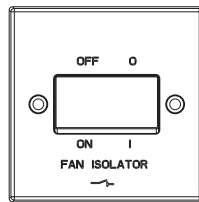
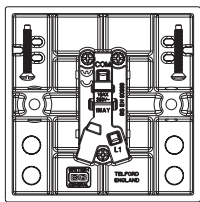

915

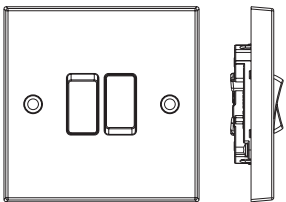
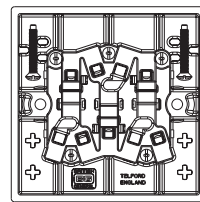

942

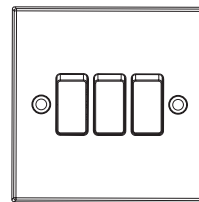
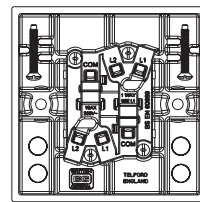

943

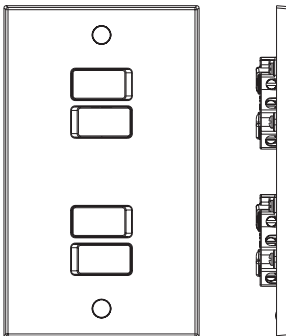
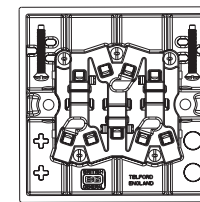

944

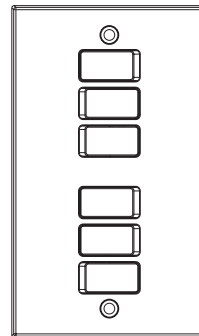
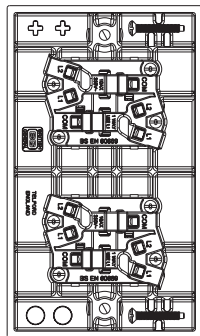

946

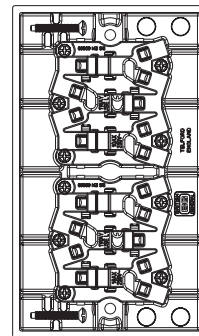

10 Amp - 10 AX Switches

Packaging Information

Cat No.	Description	Packaging Type			Pack Quantity			Barcode		
		Product	Inner Box	Outer Box	Each	Inner Box	Outer Box	Individual	Inner Box	Outer Box
911	10AX 1G,1W	Plain Bag	Plain Inner	Plain Outer	1	10	100	5021166911509	5021166911592	5021166911585
912	10AX 1G,2W	Plain Bag	Plain Inner	Plain Outer	1	10	100	5021166913503	5021166912599	5021166912582
912W	10AX 1G,2W, WideRocker	Plain Bag	Plain Inner	Plain Outer	1	10	100	5050765100069	5021166912292	5021166912285
913	10AX Intermediate	Plain Bag	Plain Inner	Plain Outer	1	10	100	5021166914500	5021166913596	5021166913589
914	10AX Bell Push	Plain Bag	Plain Inner	Plain Outer	1	10	100	5021166915507	5021166914593	5021166914586
915	10AX Fan Isolator	Plain Bag	Plain Inner	Plain Outer	1	10	100	5021166942503	5021166915590	5021166915583
942	10AX 2G,2W	Plain Bag	Plain Inner	Plain Outer	1	10	100	5021166912506	5021166942596	5021166942589
942W	10AX 2G,2W, WideRocker	Plain Bag	Plain Inner	Plain Outer	1	10	100	5050765100090	5021166942299	5021166942282
943	10AX 3G,2W	Plain Bag	Plain Inner	Plain Outer	1	5	50	5021166943500	5021166943593	5021166943586
944	10AX 4G,2W	Plain Bag	Plain Inner	Plain Outer	1	5	50	5021166944507	5021166944590	5021166944583
946	10AX 6G,2W	Plain Bag	Plain Inner	Plain Outer	1	5	50	5021166946501	5021166946594	5021166946587

Weights & Dimensions

Cat No.	Description	Dimension (W x L x H) cm			Weight (g)			CBM (m ³)
		Product	Inner Box	Outer Box	Each	Inner Box	Outer Box	Outer Box
911	10AX 1G,1W	8.6 x 8.6 x 2.1	12 x 15.8 x 9.2	25.1 x 48 x 16.5	65	650	7400	0.0244
912	10AX 1G,2W	8.6 x 8.6 x 2.1	12 x 15.8 x 9.2	25.1 x 48 x 16.5	65	650	7450	0.0244
912W	10AX 1G,2W, WideRocker	8.6 x 8.6 x 2.1	12 x 15.8 x 9.2	25.1 x 48 x 16.5	65	650	7400	0.0244
913	10AX Intermediate	8.6 x 8.6 x 2.1	12 x 15.8 x 9.2	25.1 x 48 x 16.5	84	840	10000	0.0244
914	10AX Bell Push	8.6 x 8.6 x 2.1	12 x 15.8 x 9.2	25.1 x 48 x 16.5	59	590	6900	0.0244
915	10AX Fan Isolator	8.6 x 8.6 x 2.1	12 x 15.8 x 9.2	25.1 x 48 x 16.5	83	830	9700	0.0244
942	10AX 2G,2W	8.6 x 8.6 x 2.1	12 x 15.8 x 9.2	25.1 x 48 x 16.5	84	840	9100	0.0244
942W	10AX 2G,2W, WideRocker	8.6 x 8.6 x 2.1	12 x 15.8 x 9.2	25.1 x 48 x 16.5	84	840	9100	0.0244
943	10AX 3G,2W	8.6 x 8.6 x 2.1	12 x 15.8 x 9.2	25.1 x 48 x 16.5	90	900	10270	0.0244
944	10AX 4G,2W	8.6 x 14.6 x 2.1	11.6 x 15.1 x 9.2	24.2 x 48.1 x 15.8	126	630	7370	0.0244
946	10AX 6G,2W	8.6 x 14.6 x 2.1	11.6 x 15.1 x 9.2	24.2 x 48.1 x 15.8	75	750	9100	0.0244

Installation Information

Safety Warning

For your safety, this product must be installed in accordance with local building regulations. If in any doubt, or where required by the law, consult a competent person who is registered with an electrical self-certification scheme.

Further information is available online or from your Local Authority.

Please read carefully and use in accordance with these safety wiring instructions.

Before commencing any electrical work ensure the supply is switched off at the mains either by switching off the consumer unit or by removing the appropriate fuse. Wiring should be in accordance with the latest edition of the IET regulations (BS 7671). To prevent fire hazard always use cable of the correct rating, size and type for the application.

Any bare earth wires must be covered with appropriate green/yellow sleeving.

Warning do not exceed the load rating of this device as stated on the rear of the product.

If in doubt consult a competent electrician.

Wire Identification – Twin & Earth Cable

EARTH = Green/Yellow Sleeving

NEUTRAL = Black (pre Apr 04) / Blue (after Apr 04)

LIVE = Red (pre Apr 04) / Brown (after Apr 04)



Technical Helpline: 03300 249 279

If in doubt consult a competent electrician.

The ends of the individual conductors should have the insulation removed by approx. 12mm. Any bare earth conductors should be sleeved to within 12mm of the ends. (These details are for general information only and conductor lengths may need to be trimmed in certain installations).

General Installation Instructions

- 1) If using the new product to replace an old one, note the cable connections and wire up new product in the same way as the old one, with Earthing as stated in these instructions.
- 2) Ensure the mounting box (metal or patress) for either flush or surface mounting is the appropriate size for the product.
- 3) Route the cable through the most suitable entry point of the mounting box. If a metal box is used, a protective cable grommet should be used.
- 4) Cables should be prepared so a sufficient conductor length reaches the terminals. Strip the ends of the individual conductors so that an adequate length enters the terminals.
- 5) Carefully arrange the wiring to lie along the edges of the product or box, keeping the central area clear.
- 6) To assist with the correct installation please consult the appropriate wiring diagram on this leaflet.
- 7) When connecting the new accessory ensure that only the bare end of the wire enters the terminal, and no bare wires are visible.

Always tighten the terminal screws securely, but do not overtighten.

An earth connection should always be made between the mounting box earth terminal, and the accessory earth terminal, where fitted. If this earth wire is bare, it is essential that it is sheathed with a length of green/yellow sleeving.

8) Carefully position the accessory into the wall box, ensuring that no wires are trapped between the plate and the wall. Do not overtighten the screws. (Fit screw covers + clip-on)

9) Once work has been completed correctly, replace the fuse for the circuit, switch the power back on, and test.

The product is now ready for use.

* Note - If your installation uses a four lug metal mounting box, remove the top and bottom lugs or bend fully back.

10 Amp - 10 AX Switches

Installation Information

One Way Switching

One way switching is used in installations that require just one switch to control a light (or circuit) i.e. on or off.

A two-way switch can be used for one-way connection, use COM and L1 terminals.

For multiple gang switches (2, 3, 4 & 6) repeat wiring method for each switch.

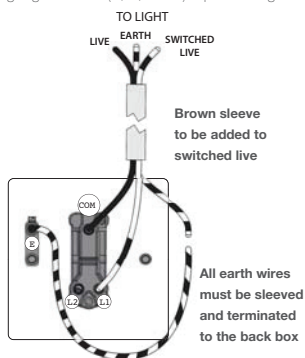

Bell Push

The bell push is a one way switch with a retractive rocker switch. Before installing, ensure a bell unit is suitable for supply voltage.

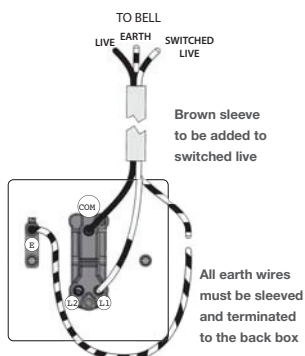

Two Way Switching

Two way switching is used where a light is controlled by two switches.

For multiple gang switches (2, 3, 4 & 6) repeat wiring method for each switch.

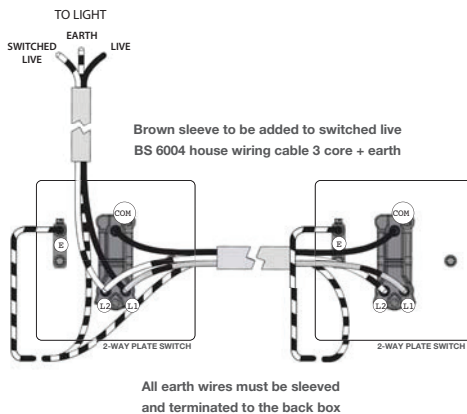

Intermediate Switching

Intermediate switching is used in installations that require three or more switches to control a light, and should be used together with two 2-way switches.

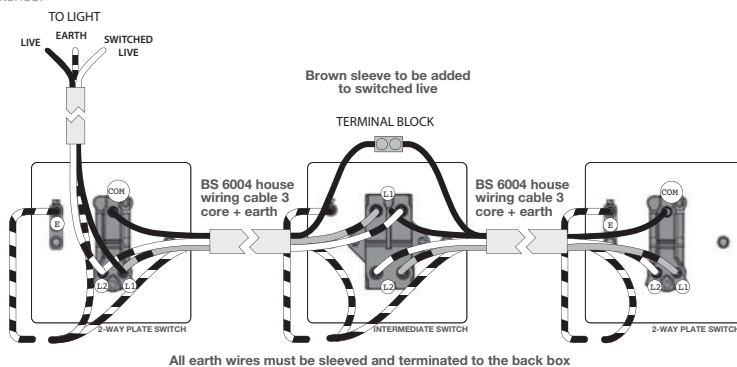

Fan Isolator - 3 Pole Switch

During repair or installation or routine maintenance the power supply to the fan unit must be disconnected. This isolating switch can be installed as shown in the diagrams to enable the remainder of the circuit to remain live.

These instructions should be read in conjunction with the instructions supplied with the fan unit and the latest IEE Wiring Regulations.

Please follow the appropriate wiring diagram below for your particular installation.

Important

The continuity of the protective conductors must be maintained. The isolator switch shall be so situated as to be inaccessible to a person using a fixed bath or shower.

