

Product Code: CUEB8MS6

Description: 8 Way Metal Consumer Unit with 100A Mains Switch (6 Free Ways)

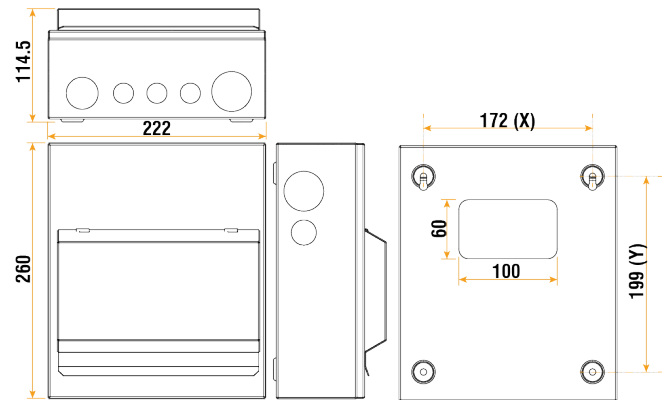

General Information

Dimensions With Door	222mm (W) x 260mm (H) x 115mm (D)	
Enclosure Dimensions	222mm (W) x 260mm (H) x 92mm (D)	
Fixing Centres	172mm (X) x 199mm (Y)	
Fixing Point Dimensions	Fixing Aperture Ø6.5mm (Ø8.5mm For Key Slot Entry)	
Materials	Enclosure & Cover: Powder Coated Steel DIN Rail: Galvanised Steel	
Finish	White (RAL 9003)	
Rated Operational Voltage (U_n)	230V~ 50/60Hz	
Maximum Rated Current (I_n)	100A	
Number Of Ways	Total Ways: 8	Free Ways: 6
Blank Modules Supplied	2 (Product Code: CU1BLANK)	
Knockouts (mm)	Sides:	1 x Ø25mm & 1 x Ø40mm
	Top & Bottom:	3 x Ø20mm, 1 x Ø32mm & 1 x Ø40mm
	Rear:	100mm x 60mm
Rated Conditional Short Circuit Current	16kA	
Device Terminal Type	Screwed Lug & Pin	
Mains Switch-Disconnecter Fitted	1 x 100A (CU2MS100)	
Terminal Capacity	35mm ²	Maximum Torque: 2.5Nm
CPC & Neutral Terminal Type	Screw	
Terminal Capacity	16mm ²	Maximum Torque: 2.0Nm
Tails Clamp Terminal Capacity	25mm ²	Maximum Torque: 1.5Nm
Operational Temperature	-5°C to +40°C	
Impact Rating (Indoor)	IK05	
Ingress Protection	IP20	
Humidity	95% Max.	
Warranty (Devices)	3 Years	
Warranty	10 Years	

Standards BS EN 61439-3 BS EN 60947-3

Additional Information Elucian metal consumer units allow compliance with BS 7671 Wiring Regulations