

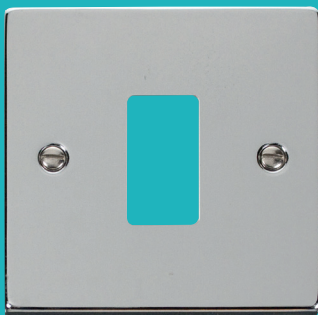

GRIDPRO Interchangeable Plates



GRIDPRO plates are all unfurnished for easy and quick configuration with the required modules.

The 1 to 24 Gang plates designed for GRIDPRO are available from each of the existing Click wiring accessory ranges. These new additions seamlessly match the range they belong to, including standard fixing centres allowing uniform alignment. All range finishes and warranties apply to the new GRIDPRO plates.

GRIDPRO Interchangeable Plates

Product Range

Finish Comparison



Antique Brass (AB)

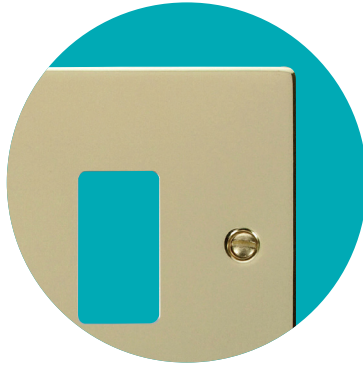

Polished Brass (BR)

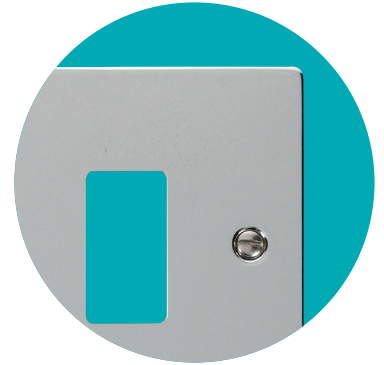

Polished Chrome (CH)



Satin Chrome (SC)

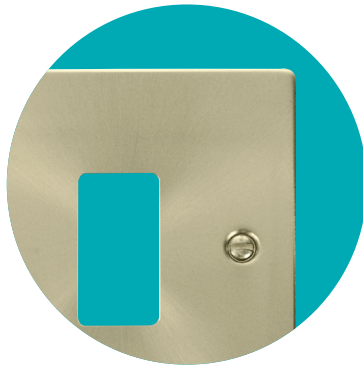

Satin Brass (SB)

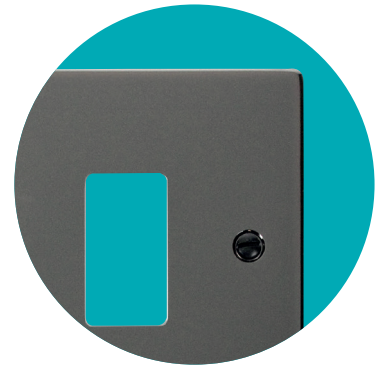

Black Nickel (BN)

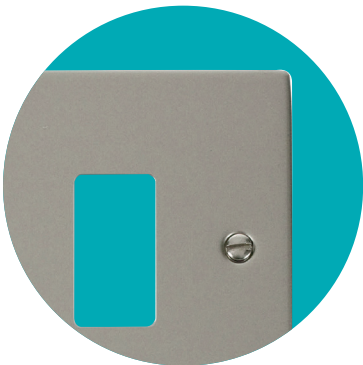

Pearl Nickel (PN)



Stainless Steel (SS)

GRIDPRO Interchangeable Plates

Product Range

GRIDPRO Interchangeable Plates

VP**20401	1 Gang Deco Grid Plate
VP**20402	2 Gang Deco Grid Plate
VP**20403	3 Gang Deco Grid Plate
VP**20404	4 Gang Deco Grid Plate



VPCH20401



VPSC20402



VPSS20403

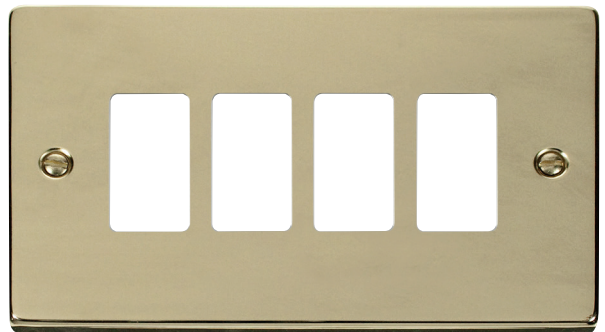

VPBR20404



Errors & Omissions excluded. Specification is subject to change without notice. ** Denotes Plate Finish. Utilizes standard 1 gang and 2 gang BS4662 back boxes.

V1.0

Scolmore International Ltd, 1 Scolmore Park, Landsberg, Lichfield Road Ind. Estate, Tamworth, Staffordshire, B79 7XB

Telephone: 01827 63454

E-mail: sales@scolmore.com, technical@scolmore.com

Facsimile: 01827 63362

Website: www.scolmore.com

GRIDPRO Interchangeable Plates

Product Dimensional Drawings (mm)

VP**20401

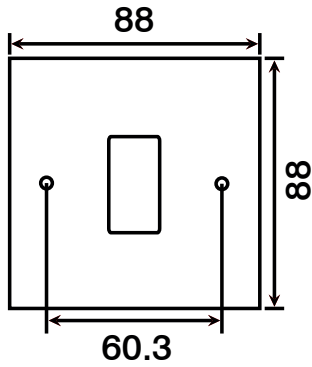

VP**20402

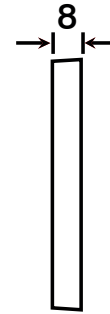
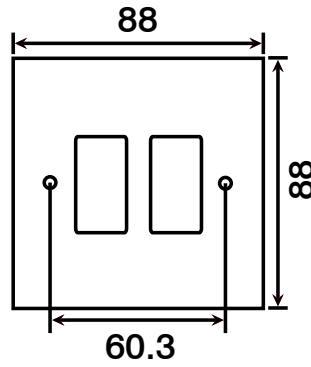

VP**20403

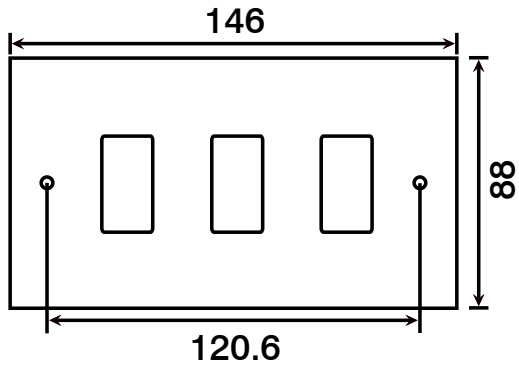

VP**20404

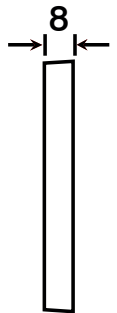
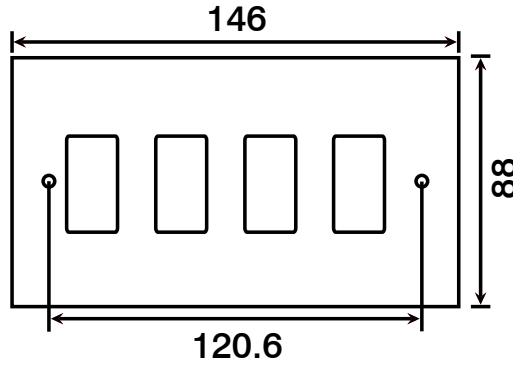

Errors & Omissions excluded. Specification is subject to change without notice. ** Denotes Plate Finish. Utilizes standard 1 gang and 2 gang BS4662 back boxes.

GRIDPRO Interchangeable Plates

Product Range

GRIDPRO Interchangeable Plates

VP**20506	6 Gang Deco Grid Plate
VP**20508	8 Gang Deco Grid Plate
GR20400	3 - 4 Module Yoke
WA512	2 Gang Double Row K/O Box 47mm Deep



VPPN20506

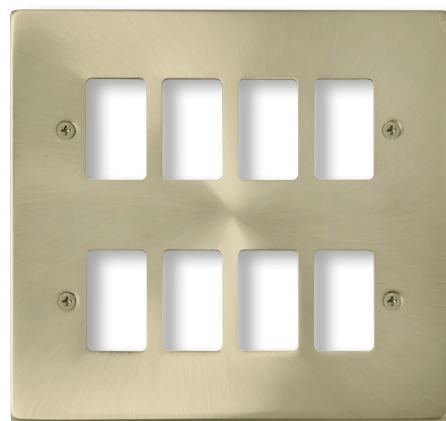

VPSB20508



GR20400

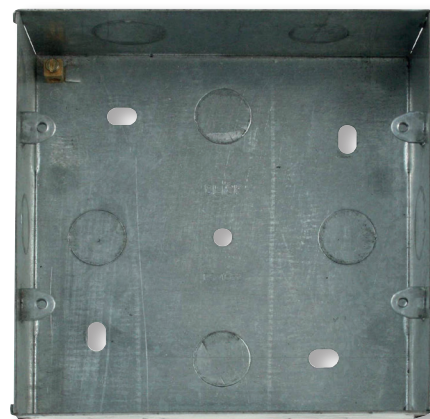

WA512



Errors & Omissions excluded. Specification is subject to change without notice. ** Denotes Plate Finish. GR20400 to be used with all plate sizes.

V1.0

Scolmore International Ltd, 1 Scolmore Park, Landsberg, Lichfield Road Ind. Estate, Tamworth, Staffordshire, B79 7XB

Telephone: 01827 63454

E-mail: sales@scolmore.com, technical@scolmore.com

Facsimile: 01827 63362

Website: www.scolmore.com

GRIDPRO Interchangeable Plates

Product Range

GRIDPRO Interchangeable Plates

VP**20509	9 Gang Deco Grid Plate
VP**20512	12 Gang Deco Grid Plate
GR20400	3 - 4 Module Yoke
WA518	2 Gang Triple Row K/O Box 47mm Deep

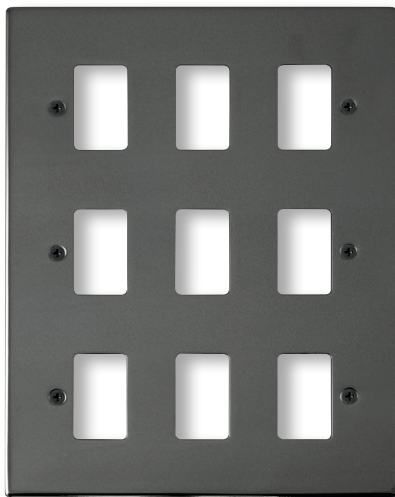

VPBN20509

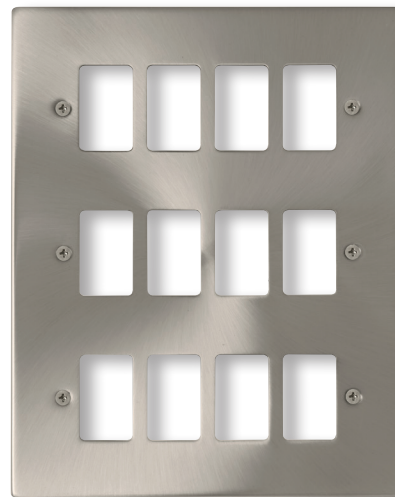

VPSC20512



GR20400

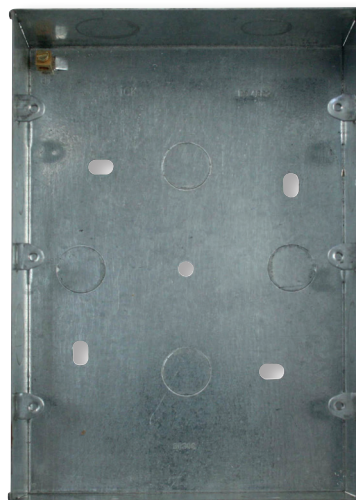

WA518



Errors & Omissions excluded. Specification is subject to change without notice. ** Denotes Plate Finish. GR20400 to be used with all plate sizes.

V1.0

Scolmore International Ltd, 1 Scolmore Park, Landsberg, Lichfield Road Ind. Estate, Tamworth, Staffordshire, B79 7XB

Telephone: 01827 63454

E-mail: sales@scolmore.com, technical@scolmore.com

Facsimile: 01827 63362

Website: www.scolmore.com

GRIDPRO Interchangeable Plates

Product Dimensional Drawings (mm)

VP**20506

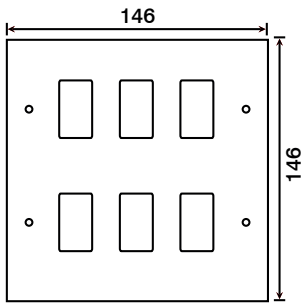

VP**20508

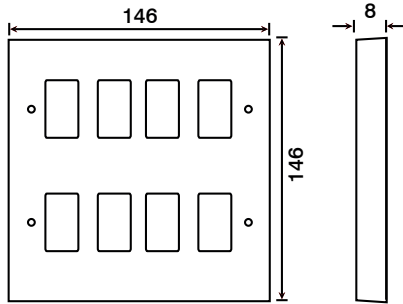

WA512

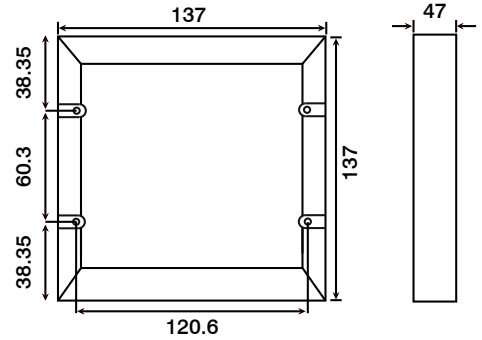

VP**20509

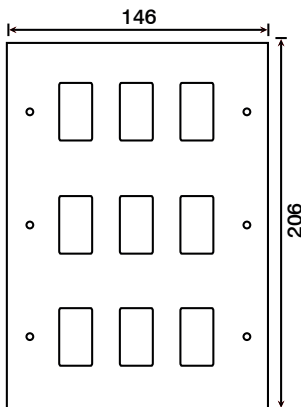

VP**20512

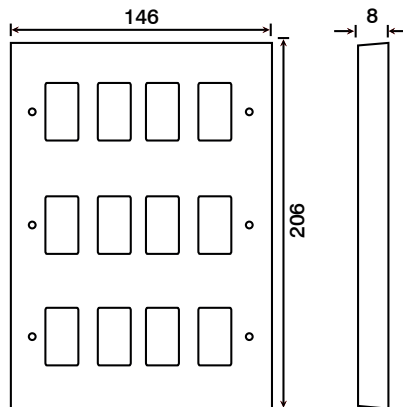

WA518

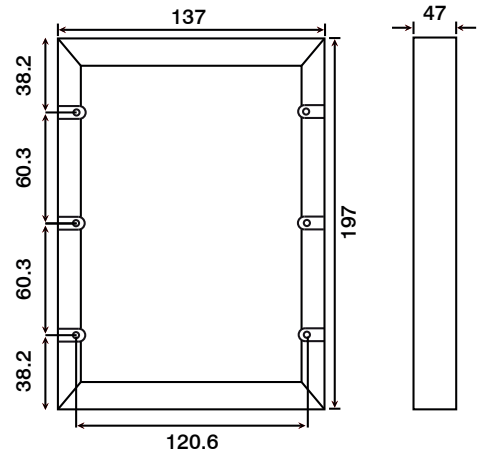

GR20400

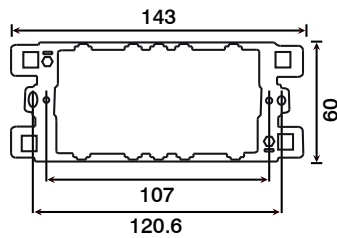

Errors & Omissions excluded. Specification is subject to change without notice. ** Denotes Plate Finish. GR20400 to be used with all plate sizes.

GRIDPRO Interchangeable Plates

Product Range

GRIDPRO Interchangeable Plates

VP**20518	18 Gang Deco Grid Plate
VP**20524	24 Gang Deco Grid Plate
GR20600	6 Module Yoke
WA20518	18 Gang K/O Box 56mm Deep
WA20524	24 Gang K/O Box 56mm Deep

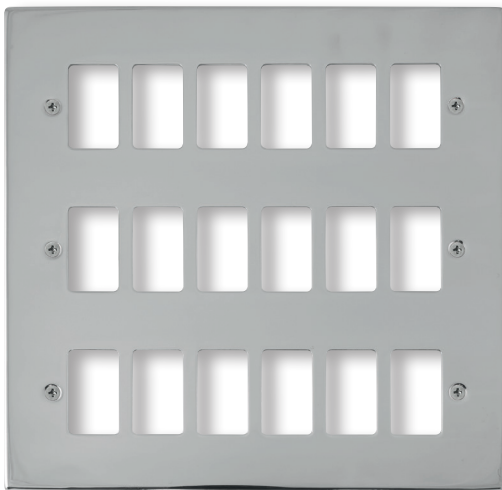

VPCH20518

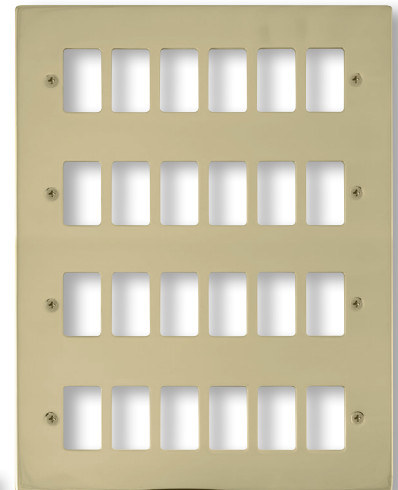

VPBR20524



GR20600



WA20518



WA20524

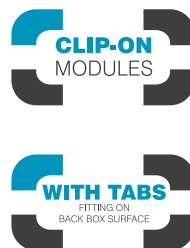

Errors & Omissions excluded. Specification is subject to change without notice. ** Denotes Plate Finish. GR20600 to be used with all plate sizes.

V1.0

Scolmore International Ltd, 1 Scolmore Park, Landsberg, Lichfield Road Ind. Estate, Tamworth, Staffordshire, B79 7XB

Telephone: 01827 63454

E-mail: sales@scolmore.com, technical@scolmore.com

Facsimile: 01827 63362

Website: www.scolmore.com

GRIDPRO Interchangeable Plates

Product Dimensional Drawings (mm)

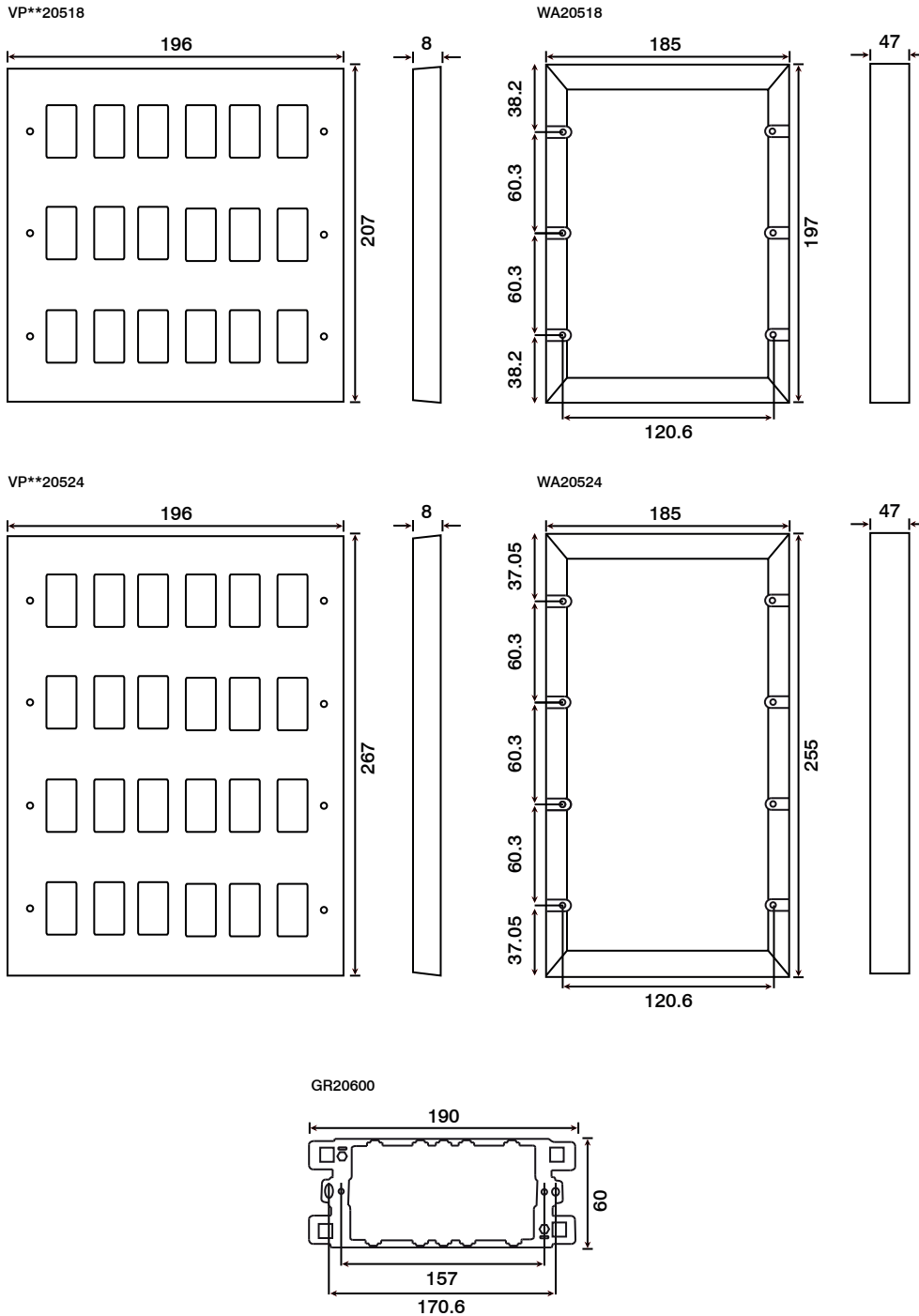

Errors & Omissions excluded. Specification is subject to change without notice. ** Denotes Plate Finish. GR20600 to be used with all plate sizes.

GRIDPRO Interchangeable Plates

Technical Specification

GRIDPRO Interchangeable Plates

Material Composition	Front Plate: Stainless Steel GR20400 & GR20600 Mounting Yoke: Galvanised Steel Earth Terminal: Brass Earth Strap: Mild Steel Back Boxes: Galvanised Steel
Cable Size	Dependent on modules fitted
Back Box Depth	Dependent on modules fitted
Modular	Yes
Warranty	10 Years
IP Rating	IP20
Operational Temperature	-5° to +40°C
Standards	BS 5733 : 2010 + A1 : 2014 BS 4662: 2006 + A1: 2009 (Back Boxes)

Additional Information

Ensure that the mains supply is isolated before commencing installation and refer to the circuit diagram with the relevant product.

Bare earth cables must always be covered with appropriate sleeving and wired to the earth terminal.

VP**20506 & VP**20508 requires (2x) GR20400 3-4 Module Mounting Yokes. These plates are designed to be used with specified back box WA512.

VP**20509 & VP**20512 requires (3x) GR20400 3-4 Module Mounting Yokes. These plates are designed to be used with specified back box WA518.

VP**20518 requires (3x) GR20600 6 Module Mounting Yokes. These plates are designed to be used with specified back box WA20518.

VP**20524 requires (4x) GR20600 6 Module Mounting Yokes. These plates are designed to be used with specified back box WA20524.

Interchangeable with modules in the GRIDPRO system.



EU DECLARATION OF CONFORMITY

1. *Issuer Name* Scolmore International Limited
2. *Issuer Address* 1 Scolmore Park, Landsberg,
Lichfield Road Industrial Estate,
Tamworth, Staffordshire, B79 7XB
3. *Object(s) of Declaration* Deco Range
 - a. *Group* GRIDPRO Interchangeable Plates
 - b. *Model No.* VP-20401, VP-20402, VP-20403, VP-20404, VP-20506, VP-20508, VP-20509,
VP-20512, VP-20518, VP-20524

4. *The object of the declaration described above is in conformity with the requirements of the following Legislations:*

5. *All products contained within the aforementioned comply with the relevant standards and requirements listed below.*

BS 5733 : 2010 + A1 : 2014

6. *I hereby declare that the equipment named above has been designed to comply with the relevant sections of the above referenced specifications. The unit complies with all applicable Essential Requirements of the Directives.*

In conjunction with the above all manufacture and process controls are in accordance with ISO 9001:2008.

This declaration has been issued under the sole responsibility of the manufacturer, signed at, for and on behalf of: Scolmore International Limited

R Turner

Ross Turner - Technical Support Engineer