

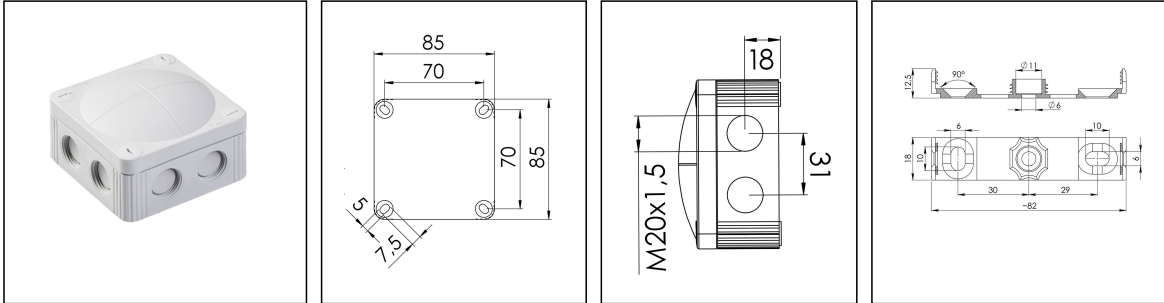

COMBI 308/empty

Junction box, polypropylene



Product illustrations are exemplary and may differ from the chosen product. Further variants and individual customization, we will gladly provide you on request.



Material	Polypropylene
Material sealing gasket	TPE
Temp. range min	-30 °C
Temp. range max	100 °C
Temperatures during install.	-5 °C - 60 °C
Protection class	IP66/67
Glow wire test	750 °C
Voltage	400 V
Terminals/poles	4 mm ²
Fixing	4 internal openings
Ø cable diameter min	3 mm
Ø cable diameter max	12 mm
External dimensions LxWxH	85 x 85 x 51mm
Type of cable gland	M 20 x 1,5
Using for cable gland	
Product Color	RAL 7035
WISKA-Order no.	10060400
Type	COMBI 308/empty
Packing unit	5
ETIM-Classification	EC002600

Remarks:

Fixing: With mounting clip or 4 internal openings outside of the sealing area

Equipment: 8 elastic self-sealing puncture-membranes for cable entry

8 intergrated M20 thread for mounting without lock nut

4 captive cover screws

WISKA Hoppmann & Mulsow GmbH
Kisdorfer Weg 28 · 24568 Kaltenkirchen · Germany
☎ +49-4191-508-0 · 📠 +49-4191-508-209
contact@wiska.com · www.wiska.com

Product Data Sheet



including mounting clip

03.11.2016

